

MaxMotion

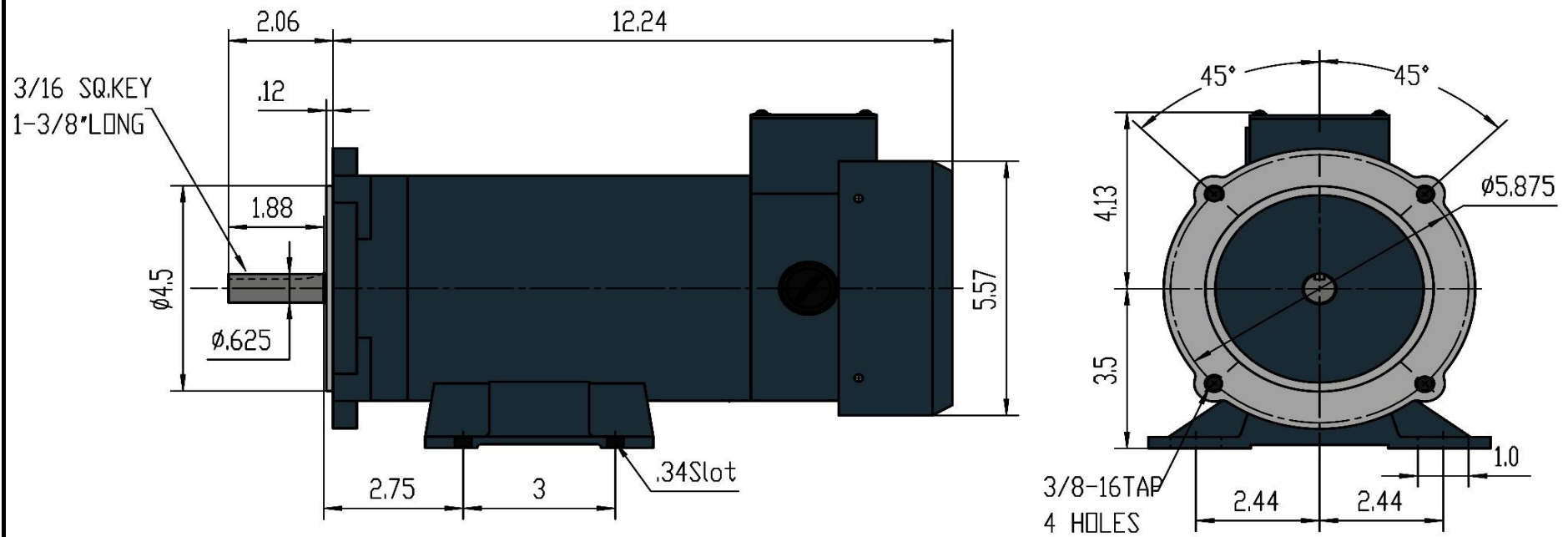

Customer is responsible in determining that MaxMotion product will fit/performance suitably in the intended application

Version: 1NIN

Revised: April 2020

HP	RPM	Voltage	Amps	Const.	Frame	Insul.	Torque	P. Code	Wgt lbs	Rated
1	1750	90Vdc	12,7	TEFC	56C	Class H	36 in/lbs	K (SCR)	33	IP45

MM1090FC